

Geberit Pluvia

Sifoninė stogų vandens surinkimo sistema

■ GEBERIT

**KNOW
HOW
INSTALLED**

Karolis Bacevičius
Prekybos ir techninis
konsultantas

Geberit Pluvia



Geberit Pluvia sistemos palyginimas su įprastine sistema

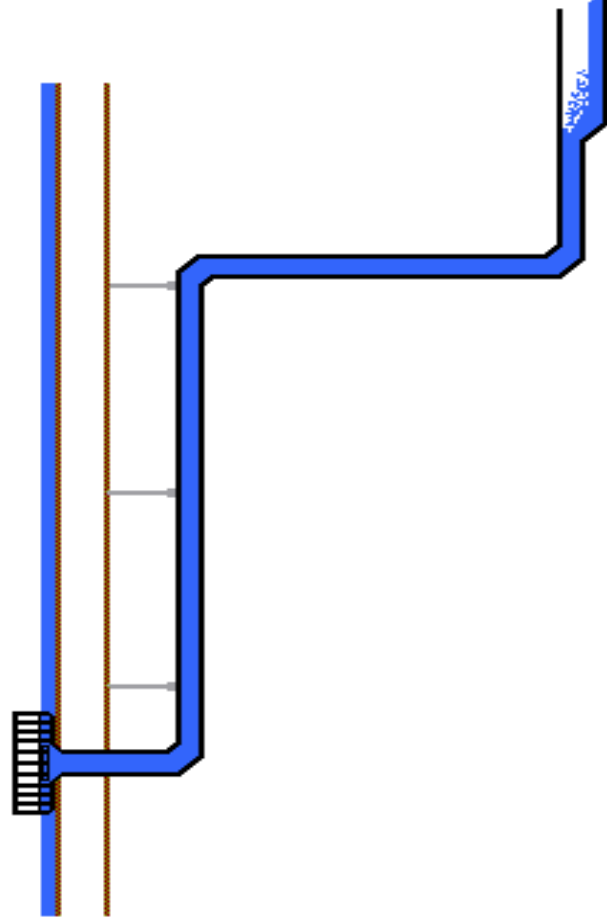

Geberit Pluvia sistema

- tik vanduo

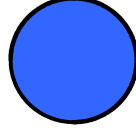

Įprasta sistema:

- oras
- vanduo

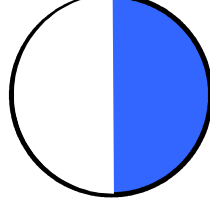

Naudojant Geberit Pluvia sistemą, lietaus nuotekų vamzdžio skermuo gali būti 2 kartus mažesnis.

Geberit Pluvia



Geberit Pluvia sistemos veiklos fazės

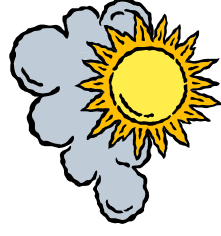
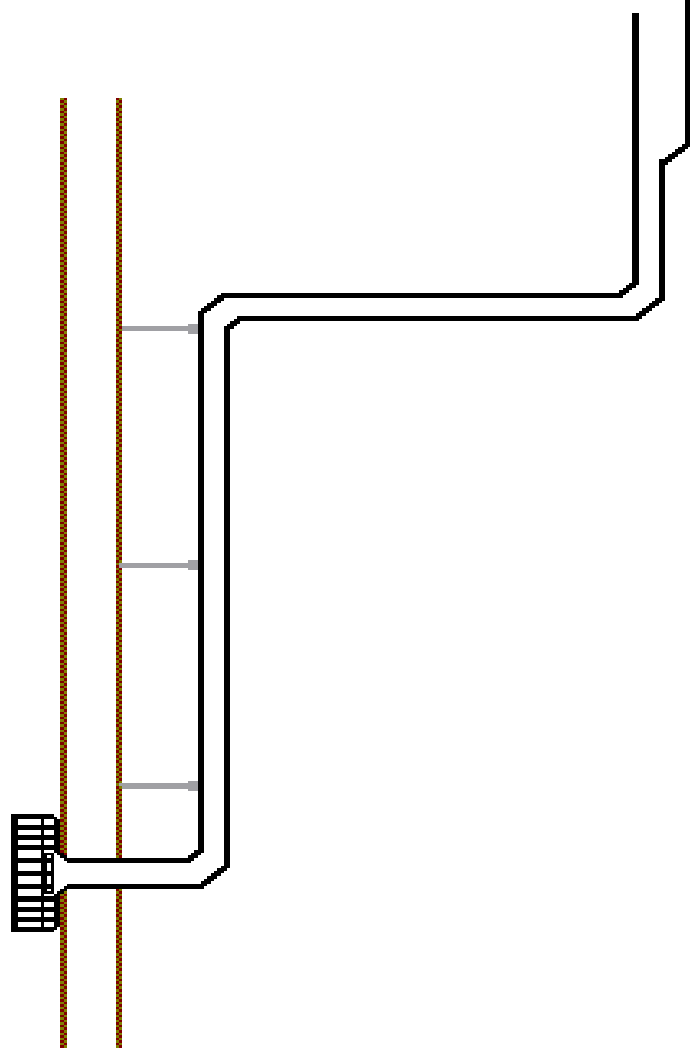

I fazė: - be kritulių

- rinktuvai tušti

Geberit Pluvia



Geberit Pluvia sistemos veiklos fazės

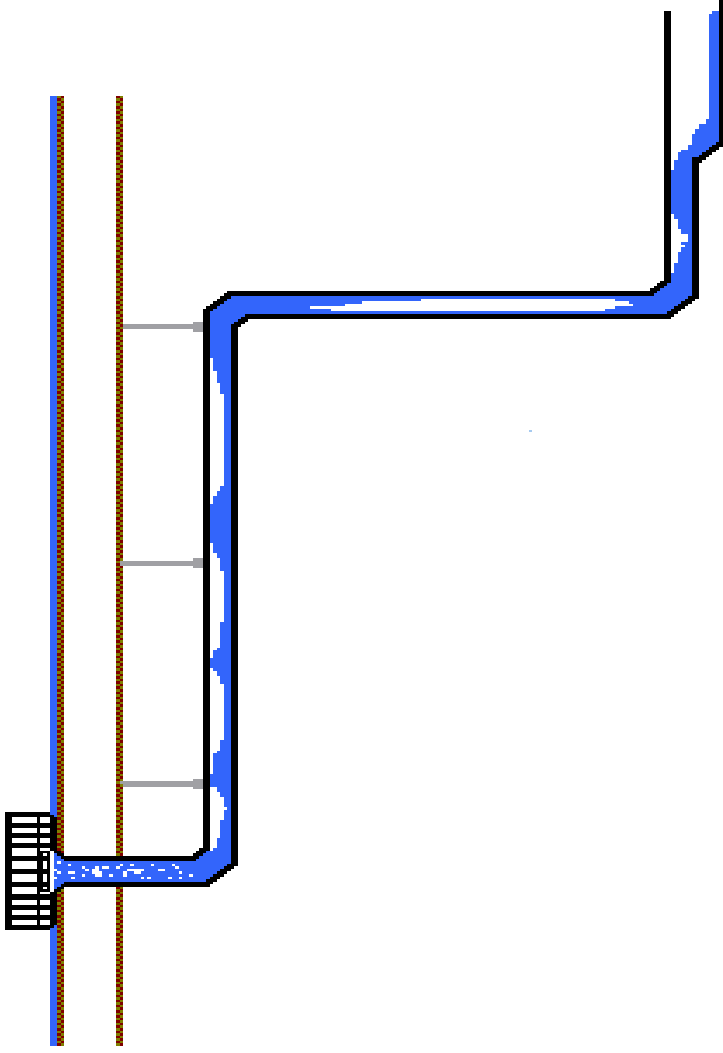

II fazė:

- nedideli krituliai

- rinktuvai užsipildo cikliškai.

Užsipildžius daliai vamzdžio vandeniu, jis yra traukiamas žemyn kartu su oru.

Toliau procesas kartojasi.

Geberit Pluvia



Geberit Pluvia sistemos veiklos fazės

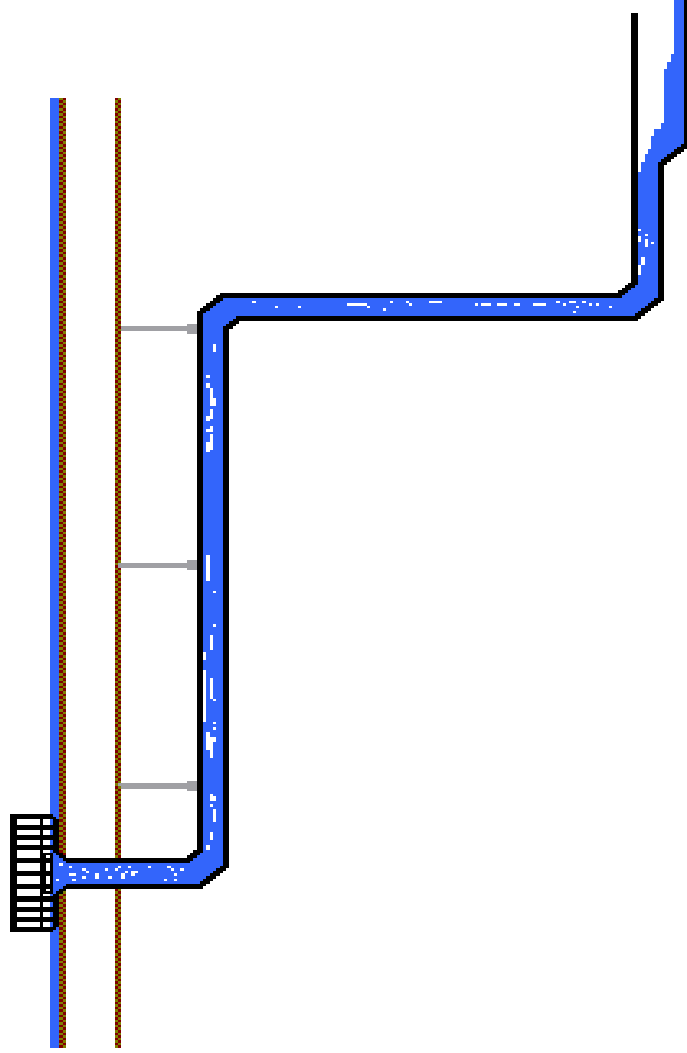

III fazė:

- intensyvūs krituliai

- rinktuvai užsipildo visiškai.

Vandenyje dar yra oro priemaišų.

Geberit Pluvia



Geberit Pluvia sistemos veiklos fazės

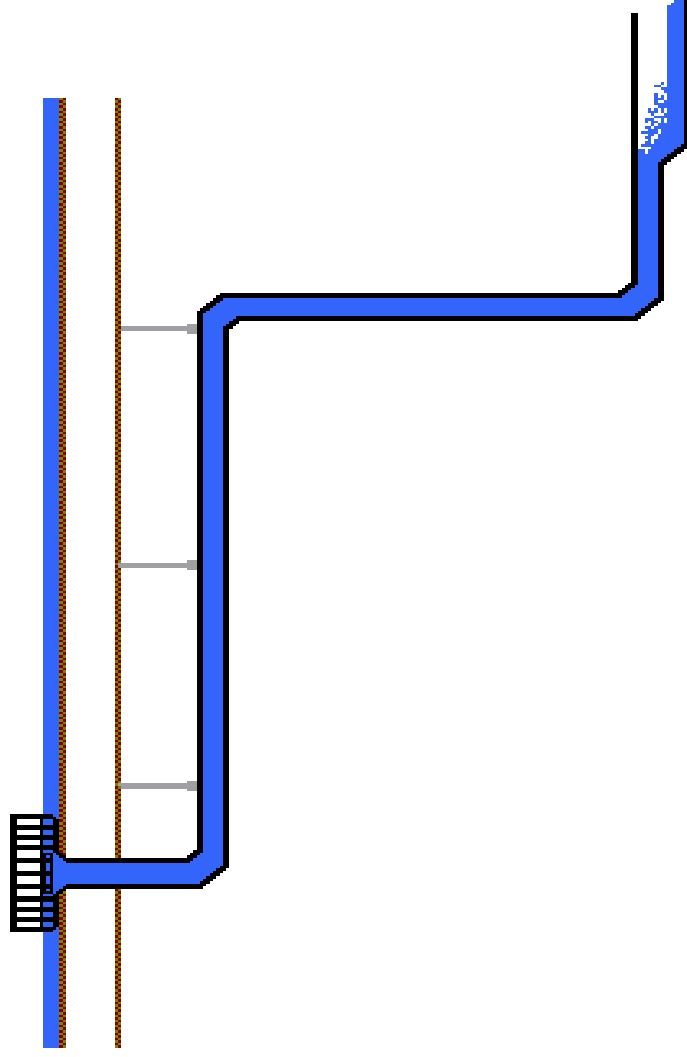

IV fazė:

- maksimalūs krituliai
(Lietuvos norma: 300l/s*ha)

- rinktuvai visiškai užsipildo vien tik vandeniu.

Geberit Pluvia



Geberit Pluvia ir įprastinės sistemos palyginimas

Įprastinė sistema:

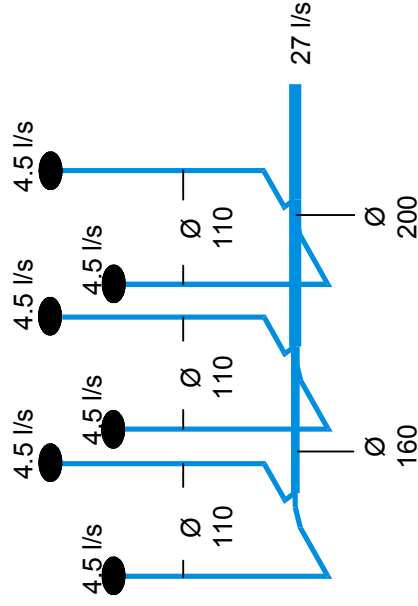

Geberit Pluvia sistema

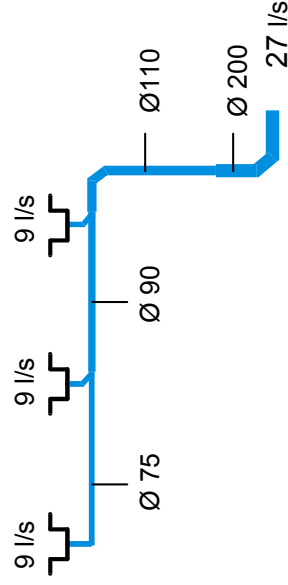

Žymiai mažesnis stovų kiekis

Geberit Pluvia



Geberit Pluvia ir įprastinės sistemos palyginimas

Įprastinė sistema

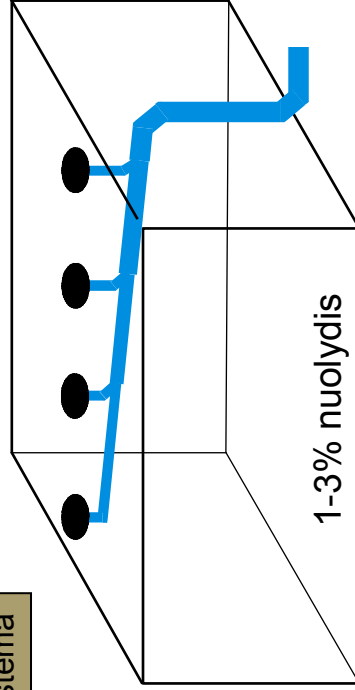

Geberit Pluvia sistema

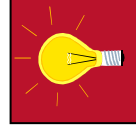
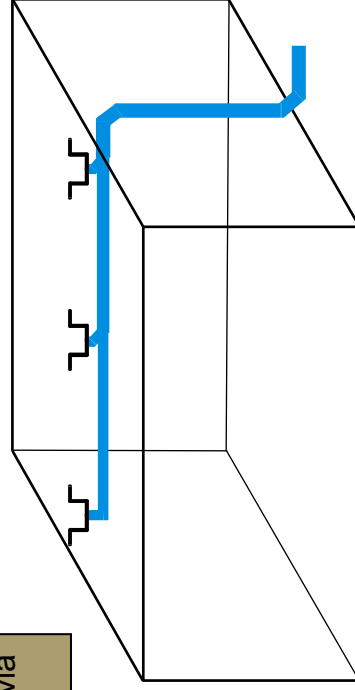

Nereikalingas
nuolydis.

Geberit Pluvia



Geberit Pluvia ir įprastinės sistemos palyginimas

Įprastinė sistema

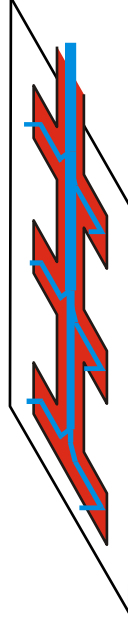
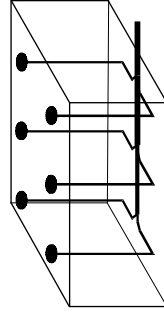

Geberit Pluvia sistema

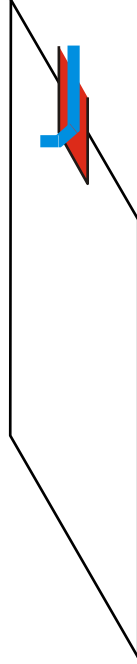
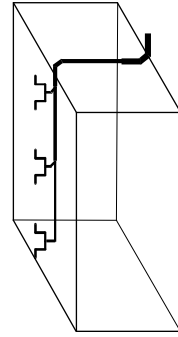

Po žeme esančių vamzdžių kiekis sumažintas iki absoliutaus minimumo.

Geberit Pluvia



Geberit Pluvia ir įprastinės sistemos palyginimas

Įprastinė sistema

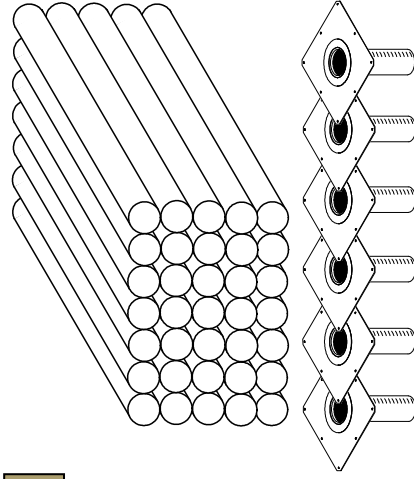

Geberit Pluvia sistema

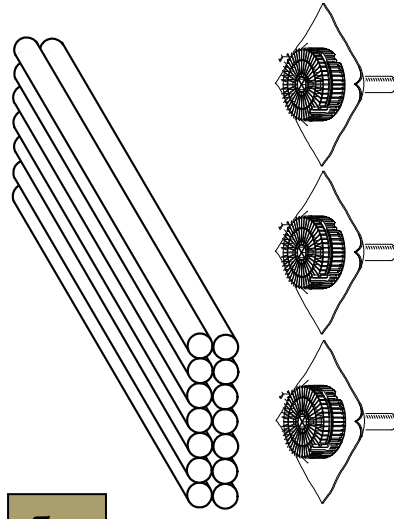

Mažesnė medžiagų
kaina



Geberit Pluvia



Geberit Pluvia sistemos elementai:

- Geberit Pluvia stogo vandens rinktuvai
- Geberit HDPE vamzdžiai ir jungtys
- Geberit Pluvia laikiklių sistema
- Geberit Pluvia skaičiavimo programa
- Techniniai konsultantai
- Garantija

Geberit Pluvia

Geberit Pluvia objektai

 **GEBERIT**

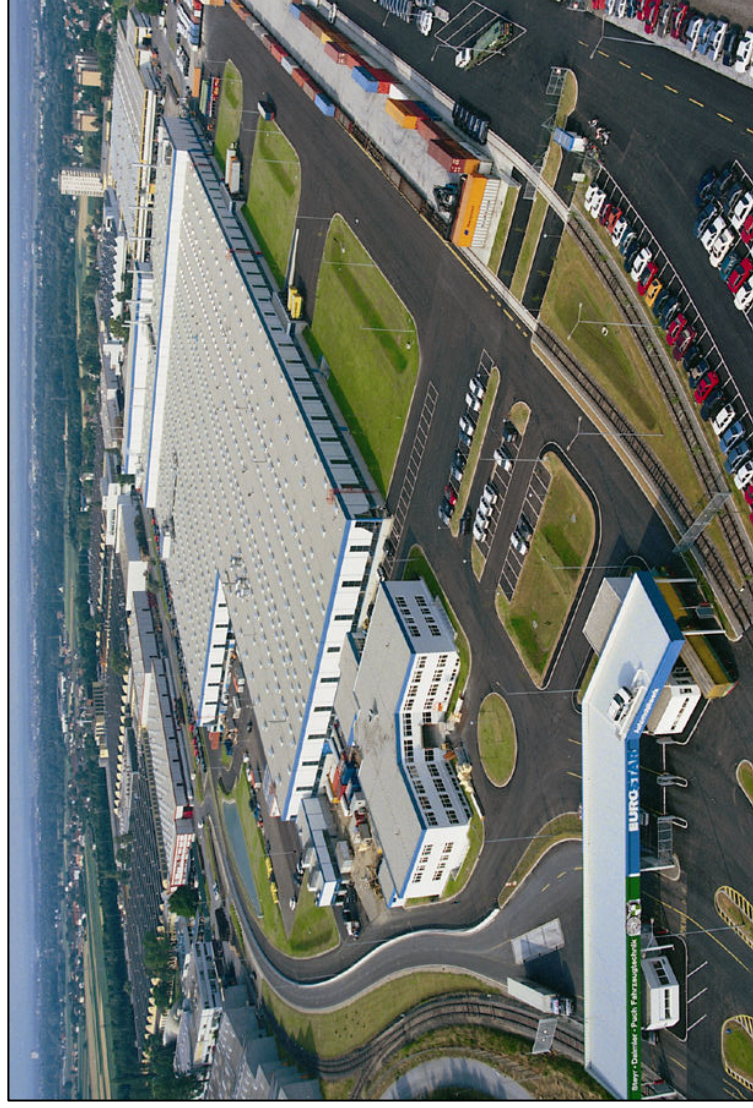

Stogo plotas: 47'000m²
Rinktuvų kiekis: 250 vnt.
Vamzd. Skersm.: Ø40-200mm
Vamzdžio kiekis: 2'500m

Chrysler automobilių gamykla, Graz, Austria

Geberit Pluvia

Geberit Pluvia objektai

 **GEBERIT**



Citroen automobilių gamykla, Prancūzija



Stogo plotas: 95'000m²

Rinktuvų kiekis: 500 vnt.

Vamzd. Skersm.: Ø40-200mm

Vamzdžio kiekis: 10'000m

Geberit Pluvia

Geberit Pluvia objektai

 **GEBERIT**



Stogo plotas: 160'000m²

Rinktuvų kiekis: 800 vnt.

Vamzd. Skersm. : Ø40-250mm

Vamzdžio kiekis: 10'000m

Ford automobilių gamykla, Lisabona, Portugalija

Geberit Pluvia



Geberit Pluvia objektai



Futbolo stadionas, Kopenhaga, Danija

Geberit Pluvia

Geberit Pluvia objektai

 **GEBERIT**



Globe Air Arena, Stokholmas, Švedija



Stogo plotas: 28'000m²
Rinktuvų kiekis: 200 vnt.
Vamzd. Skersm.: Ø40-160mm
Aukštis: 85m

Geberit Pluvia

Geberit Pluvia objektai

 **GEBERIT**



Colline de l'Automobile, Paryžius, Prancūzija



Stogo plotas: 47'000m²
Rinktuvų kiekis: 250 vnt.
Vamzdz. Skersm.: Ø40-200mm
Vamzdžio kiekis: 2'500m

Geberit Pluvia

■ GEBERIT

Geberit Pluvia objektai



Busan World Cup Stadium

Žiūrovų tribūnoje:
Užbaigimo data:
Stogo plotas:
Pluvia rinktuvų kiekis:
HDPE vamzdis:

55.982
2001 liepa
17'000 m²
64 vnt.
Ø 40 - 160 mm

Seoul World Cup Stadium

Žiūrovų tribūnoje:
Užbaigimo data:
Stogo plotas:
Pluvia rinktuvų kiekis:
HDPE vamzdis:

63.961
2001 gruodis
67'000 m²
184 vnt.
Ø 56 - 315 mm



Geberit Pluvia



Geberit Pluvia objektai



Jeonju World Cup Stadium

Žiūrovų tribūnoje: 42.391
Užbaigimo data: 2001 rugšėjis
Stogo plotas: 24'000 m²
Pluvia rinktuvų kiekis: 100 vnt.
HDPE vamzdis: ø 56 - 250 mm

Suwon World Cup Stadium



Žiūrovų tribūnoje: 43.188
Užbaigimo data: 2001 gegužė
Stogo plotas: 19'000 m²
Pluvia rinktuvų kiekis: 72 vnt.
HDPE vamzdis: ø 40 - 160 mm



Geberit Pluvia

Geberit Pluvia objektai

■ **GEBERIT**



Jeju World Cup Stadium

Žiūrovų tribūnoje:

Užbaigimo data:

Stogo plotas:

Pluvia rinktuvų kiekis:

HDPE vamzdis:

42.256

2001 Gruodis

16'000 m²

50 vnt.

Ø 50 - 250 mm





Geberit Pluvia



Geberit Pluvia objektai

- 40 metų patirtis
- 65'000 įgyvendintų projektų
- 80'000'000 m² stogo ploto
- 500'000 sumontuota rinktuvų